

## QUICK START GUIDE

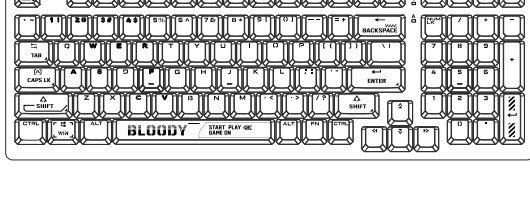

## WHAT'S IN THE BOX

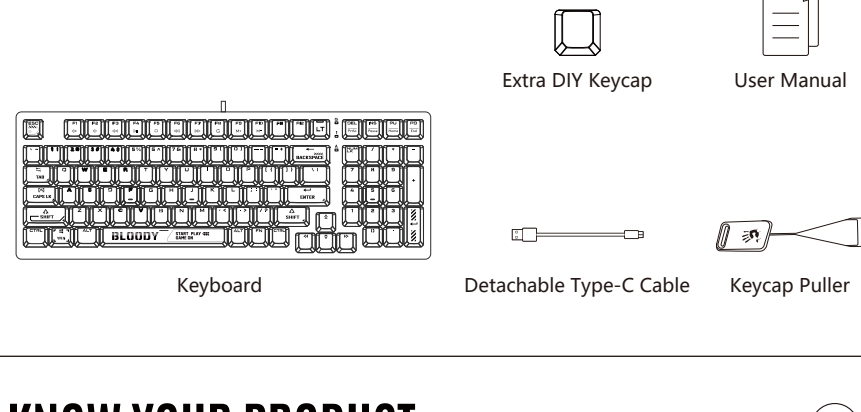

## KNOW YOUR PRODUCT

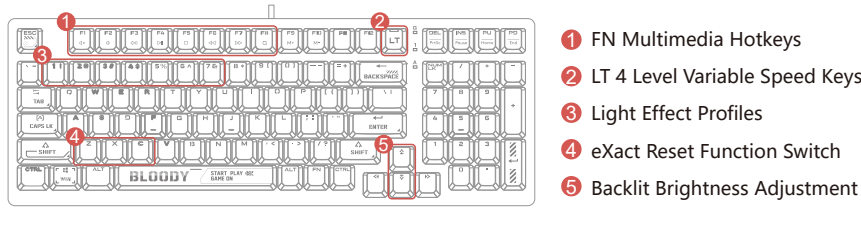

## INSTALLATION

Connect the cable Type-C plug to the keyboard and the USB plug to the computer. (Note: Using a USB hub or extension cable to connect is not recommended.)

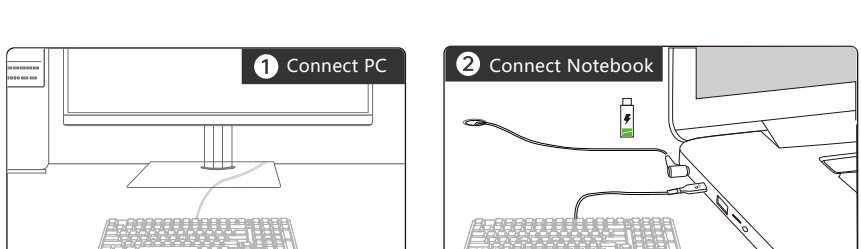

## CUSTOMIZABLE LT VARIABLE SPEED PROFILES

Switch between 4 customization actuation levels. With the software, customize up to 23 actuation points (0.8mm to 3.0mm) for all keys or individual keys, creating fully personalized profiles.

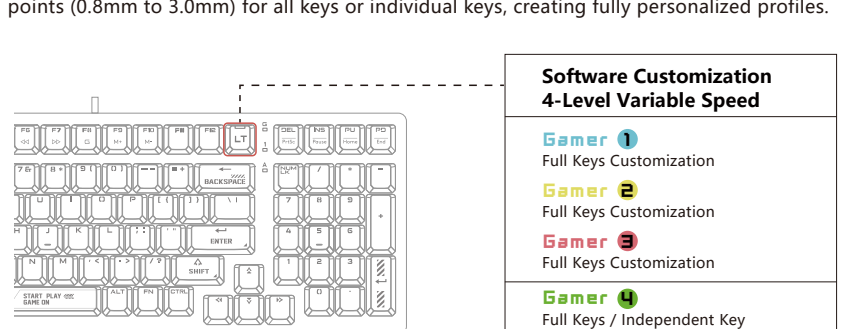

## EXACT RESET SYSTEM

When Hyper Z-Force Mode or Extreme X-Force Mode is enabled, the reset occurs at a much shorter distance, allowing for quicker key presses and improving overall responsiveness. This enhances reaction time and performance in various gaming scenarios.

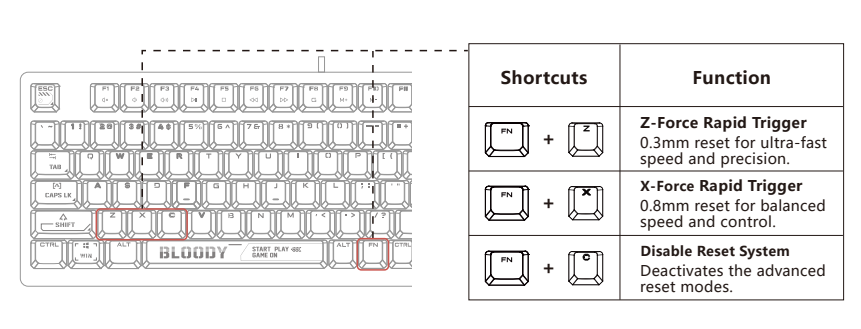

## KEYDOMINATOR EDITING SOFTWARE



## SOFTWARE DOWNLOAD

For optimal product performance and access to advanced customization features, please download and install the software from <http://bloody.com/en/download.php>.

- 1. Keystroke Setting**  
Customize keyboard function emulation, programmed keys, shortcut keys, and other settings to suit your preferences.
- 2. Actuation Point**  
Fine-tune the travel distance setting of LT optical switches for accurate typing and gaming experiences.
- 3. Macro Editor II**  
A player-centric programming platform tailored for users with programming expertise.
- 4. Combination Setting**  
A user-friendly player programming platform ideal for players without programming expertise, allowing for the creation of simple programming functions.
- 5. Ultra Combo**  
Access settings for advanced software and hardware functions.

## FULL KEYBOARD AREA CUSTOMIZATION

Access LT Optical Travel Configuration setting by clicking 'Actuation Point' in the software.

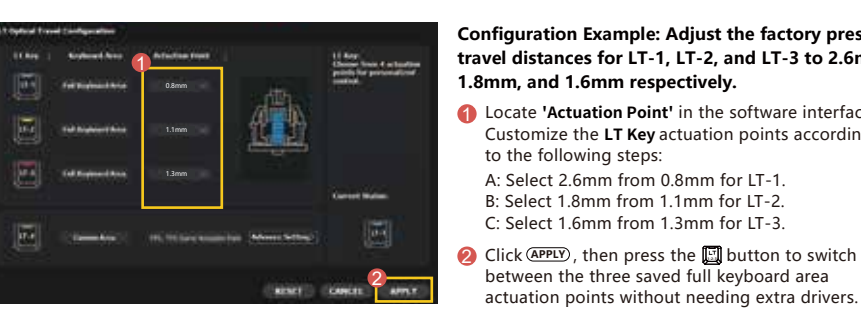

## FULL-KEY INDEPENDENT CUSTOMIZATION

Access LT Optical Travel Configuration setting by clicking 'Actuation Point' in the software.

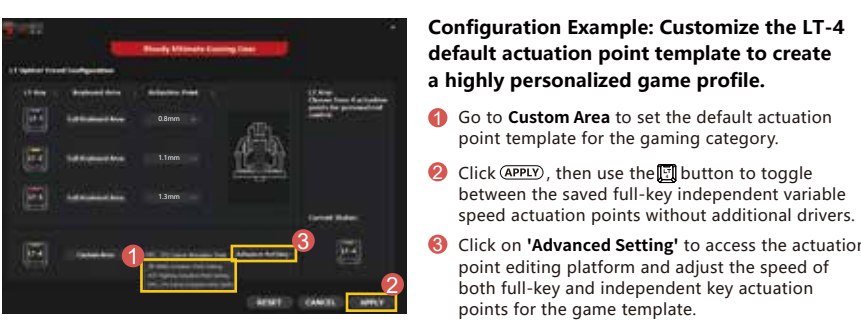

## ALPHA PLAYER CUSTOMIZATION

Game Template Configuration Example: Customize the actuation points of the WASD and space keys to 1.4mm while setting other keys to 2.0mm.

- Go to 'Travel Distance' to name your **Game Actuation Point** template. Once confirmed, a game template will be automatically generated. Then, proceed to adjust the **Full Keyboard Area** setting.
- Set the **Full Keyboard Area** to 2.0mm, then proceed to configure the Single or Multiple Key settings.
- Select **W/S/A/D** and the **<SPACE>** key to designate the actuation point as 1.4mm:  
a Red key: Set the independent key actuation point to 1.4mm  
b Black key: Set the full key actuation point to 2.0mm
- Save in **File Management**, the current edited game template will be saved.



## COMBINATION FN KEYS

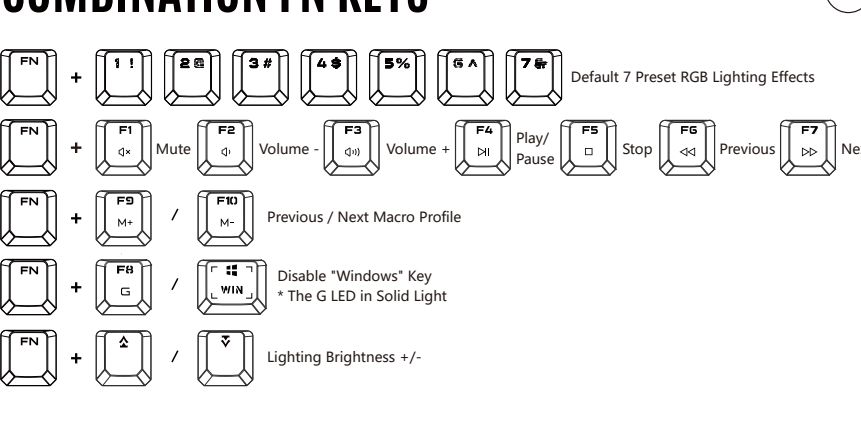

## Q & A

- Question** Can I switch the actuation points without software?  
**Answer** You may customize and save 4-level actuation points through the software, switch them by driver-free.
- Question** What are the types of the actuation points settings?  
**Answer** With the software, customize the actuation points for all keys or individual keys, creating fully personalized profiles.
- Question** Can I reset the factory default settings for the 4 LT speeds?  
**Answer** Click the [Reset] Button in the software to restore the factory default settings.
- Question** How to adjust the lighting brightness?  
**Answer** Adjust the backlit with 3-level brightness and off by pressing + /

## TECH SPEC

Switch Type	Alpha Optical Variable Speed Switch
Adjustable Actuation Point	23 Options 0.8mm~3.0mm
2-Stage RT Function	RT1: 0.3mm, RT2: 0.8mm
Number of Keys	98 Keys + 1 LT Variable Speed Key
Switch Lifetime	100 Million Keystrokes
Report Rate	1000 Hz
Onboard Memory	4M
RGB Backlit Effect	7 Lighting Effects
100% N-Key Rollover	Yes
Port	USB
Size	38.5 x 13.8 x 4.1 cm
Weight	1034g (w/ cable), 965g (w/o cable)
System	Windows 7 / 8 / 8.1 / 10 / 11



[www.Bloody.com](http://www.Bloody.com)



Scan for E-Manual